

Figure 1



Figure 2

AUTO	Auto Ranging	mV, V	Millivolt, Volt	Ω , k Ω , M Ω	Ohm, Kiloohm, Megaohm (Resistance)
-	Negative Value		Diode Check		Direct Current
	Low Battery		Audible Continuity Check		Alternating Current
OL	Overload		Bluetooth		Sharing

1. Features and Measurement Functions

- 3-3/4-digit LCD, 3999 count display
- Contoured body provides comfortable single handed grip
- Auto ranging
- Bluetooth
- Auto shut off feature to extend battery life (15 Minutes)
- Auto shut off disable feature
- Low battery indicator 
- Data logging
- Data file management
- Data file sharing
- Polarity indication: Automatic, + Implied, Negative Polarity Indicator
- Over-range indication: 'OL' or '-OL'
- Overload protection
- Resistance measurement: 0.1Ω - 40MΩ
- Continuity check: Provides an audible indication above 50Ω
- Diode check: Measure the forward voltage drop across a diode junction
- DC voltage measurement: 600 VDC max
- AC voltage measurement: 600 VAC max

2. Safety Warnings

- This instruction manual contains warnings and safety rules which must be observed by the user to ensure safe operation of the instrument and retain it in safe condition.
- Read through and understand the instructions contained in this manual before using the instrument.
- Keep the manual at hand to enable quick reference whenever necessary.
- The instrument is to be used only in its intended applications.
- Understand and follow all the safety instructions contained in the manual.
- It is essential that all safety instructions are adhered to.
- Failure to follow the safety instructions may cause injury, instrument damage.

The symbol  indicated on the instrument means that the user must refer to the related parts in the manual for safe operation of the instrument. It is essential to read the instructions wherever the symbol appears in the manual.

 **DANGER** is reserved for conditions and actions that are likely to cause serious or fatal injury.

 **WARNING** is reserved for conditions and actions that can cause serious or fatal injury.

 **CAUTION** is reserved for conditions and actions that can cause injury or instrument damage.

DANGER

- Never make measurement on a circuit in which voltage over 600V exists.
- Do not exceed the CAT rating of the measuring device.
- Do not attempt to make measurement in the presence of flammable gases.
The use of the instrument may cause sparking, which can lead to an explosion.
- Never use the instrument if its surface or your hand is wet.
- Do not exceed the maximum allowable input of any measuring range.
- Never open the battery cover during a measurement.
- The instrument is to be used only in its intended applications or conditions. Use in other than as intended may cause instrument damage or serious personal injury.

WARNING

- Never attempt to make any measurement if any abnormal conditions are noted, such as broken case, cracked test leads and exposed metal part.
- Do not change the measurement function with test leads connected to the circuit under test.
- Do not install substitute parts or make any modification to the instrument.
- Do not try to replace the batteries if the surface of the instrument is wet.
- Always switch off the instrument before opening the battery compartment cover for battery replacement.







CAUTION

- Select the proper measurement function measurement.
- Do not expose the instrument to the direct sun, high temperature and humidity or dewfall.
- Be sure to power off the instrument after use. When the instrument will not be in use for a long period, place it in storage after removing the batteries.
- Use only a soft cloth dampened with water or neutral detergent for cleaning the meter. Do not use abrasives, solvents or harsh chemicals. Allow to dry thoroughly before use.

Measurement Categories (Over-Voltage Categories)

To ensure safe operation of measuring instruments, IEC61010 establishes safety standards for various electrical environments, specified as CAT I through CAT IV, and called measurement categories. Higher-numbered categories correspond to electrical environments with greater momentary energy, so a measuring instrument designed for CAT III environments can endure greater momentary energy than one designed for CAT II.

- CAT I: Secondary electrical circuits connected to an AC electrical outlet through a transformer or similar device.
- CAT II: Primary electrical circuits of equipment connected to an AC electrical outlet by a power cord.
- CAT III: Primary electrical circuits of the equipment connected directly to the distribution panel, and feeders from the distribution panel to outlets.
- CAT IV: The circuit from the service entrance to the service entrance and to the power meter and primary over current protection device (distribution panel).

SYMBOLS	
	Important Information; Refer to manual
	Conformité Européene ("European Conformity")
	Designates the product as recyclable electronic waste per WEEE Directive
	Double Insulated
	AC (Alternating Current)
	DC (Direct Current)
	Earth ground

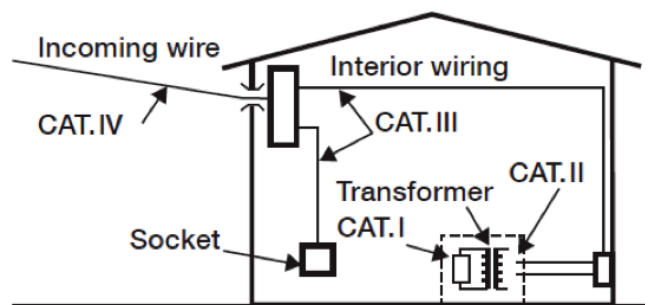

Figure 3

3. Specification

3.1 Measuring Range & Accuracy (Accuracy guaranteed at 23°C ± 5°C, humidity <75%)

TEMPERATURE COEFFICIENT		<1 X (SPECIFIED ACCURACY)/°C	
SETTING	RANGE	RESOLUTION	ACCURACY
DC Voltage	400mV	100mV	±1.2%+3
	4V	0.001V	
	40V	0.01V	±.8%+3
	400V	0.1V	
	600V	1V	±1.2%+3
AC Voltage	4V	0.001V	
	40V	0.01V	±1.0%+5
	400V	0.1V	
	600V	1V	±1.5%+5
Resistance	400Ω	0.1Ω	±1.5%+10
	4kΩ	0.001kΩ	±.1.2%+6
	40kΩ	0.01kΩ	
	400kΩ	0.1kΩ	±.1.0%+4
	4MΩ	0.001MΩ	
	40MΩ	0.01MΩ	±.2.0%+4

3.2 General Specification

- The maximum voltage allowed between terminal and ground: 600 VDC or 600 VAC
- Certifications and Compliance: Conforms to UL std. 61010-1, UL std. 61010-031, UL std. 61010-2-030, UL std. 61010-2-033, Certified to CSA std. C22.2 No. 61010-1, CSA std. 61010-031, CSA std. 61010-2-030, CSA std. 61010-2-033, CE, CAT III 600V
- Altitude: Maximum 2000m
- Display: 3-3/4-digit LCD, 3999 count
- Sampling time: 2 - 3 times / sec
- IP Degree: IP20
- Bluetooth Range: 10 Meters
- Automatic power off: 15 Minutes (Unless disabled)
- Battery type: (2) 1.5V LR44
- Operating temperature: 0°C ~ 40°C
- Storage temperature: -10°C ~ 50°C
- Size: 4.38" x 2.10" x 0.5" (111mm x 53mm x 12.7mm)
- Weight: 2.47 oz. (70 grams) (Including batteries)

3.3 Accessories



- 2 LR44 batteries
- CAT III 600V probe tip caps

4. Preparation for Measurement

4.1 Check the Condition of the Meter

Do not use a meter with visible signs of damage. Examine the meter housing before you use the product. Look for cracks, missing plastic or exposed metal. Carefully examine the wire insulation. Pay close attention to where the wire enters the meter and attaches to the probes.

4.2 Check the Battery Voltage

Press the select button to power the unit on. Confirm that the low battery symbol  is not displayed on the LCD screen. If the low battery symbol  is displayed follow the instructions in Section 8, Battery Replacement.

4.3 Check the Battery Cover



The battery cover must be in place and securely fastened before powering on the meter or connecting test leads to a circuit. See Section 8, Battery Replacement.

4.4 Check Test Lead Condition, Continuity and Rating



Do not use damaged test leads. Examine the test leads for worn or cracked insulation. Check test lead continuity. Do not use test leads in applications that exceed their CAT rating. Check the CAT rating of the test lead and refer to Figure 3. The test leads have a removable CAT III 600V probe tip cap. The meter and test leads are only CAT II 300V rated without this cap installed.

5. Measurement

5.1 DC Voltage

1. Power unit on by pressing and releasing the SELECT button.
2. Confirm that the DC symbol  appears on the screen.
3. Confirm that the V is displayed on the screen.
4. If  is not displayed press and release the SELECT button until it appears.
5. Connect the test leads to the circuit.
6. The DC voltage will be displayed on the screen.

5.2 AC Voltage

1. Power unit on by pressing the SELECT button.
2. Press and release the SELECT button until the AC symbol  appears.
3. Confirm that the V is displayed on the screen.
4. If  is not displayed press the SELECT button until it appears.
5. Connect the test leads to the circuit.
6. The AC voltage will be displayed on the screen.

5.3 Resistance

1. Power unit on by pressing and releasing the SELECT button.
2. Press and release the SELECT button until the Ω symbol appears.
3. Confirm "OL" is displayed on the screen.
4. Short the tips of the test leads together and confirm the screen shows near zero.
5. Connect the test leads across the device to be tested.
6. The resistance of the device will be displayed on the screen.

5.4 Diode Test

1. Power unit on by pressing and releasing the SELECT button.
2. Press and release the SELECT button until the Diode  symbol appears.
3. Confirm "OL" is displayed on the screen.
4. Connect the test leads probes to the anode and cathode of the diode.
5. Record the measurement displayed.
6. Reverse the connections and record the measurement displayed.

(The screen should show "OL" in one direction and a small forward voltage drop in the other. The forward voltage drop varies. Typical values are .7V for silicon diodes and .3V for germanium diodes. Please refer to the diode datasheet for specific values. If there is a voltage drop in both directions the diode is shorted. If "OL" is displayed in both directions the diode is open)

6. Features

6.1 Auto Shut Off / Auto Shut Off Disable

1. The meter has an auto shut off feature to preserve battery life.
2. When the feature is active "AutoSleep" will be displayed on your smart device.
3. The meter will shut off after 15 minutes of non-use.
4. This feature can be disabled at the time the meter is powered on by pressing and holding the SELECT button ~4 seconds.
5. This function is reset each time the unit is powered off.

6.2 Low Battery Indicator

1. The meter has a low battery indicator that will alert the user when the voltage is too low to provide accurate readings.
2. Replace the batteries when this indicator is displayed.  (See Section 8, Battery Replacement)

6.3 Polarity Indication

1. The meter displays “-“ for negative values, positive is implied.

6.4. Overload indication

1. When the input exceeds the measuring range “OL” or “-OL” is displayed on the LCD screen.

7. Smart Device & Application

- The Sperry SMARTmeter has the ability to be connected to your smart device via a Bluetooth connection.
- While the connection is established the meter will continually transmit data to your smart device.
- The measurement data will be shown in the “Measurement Display Area” of your smart device.

7.1 Interfaces and buttons

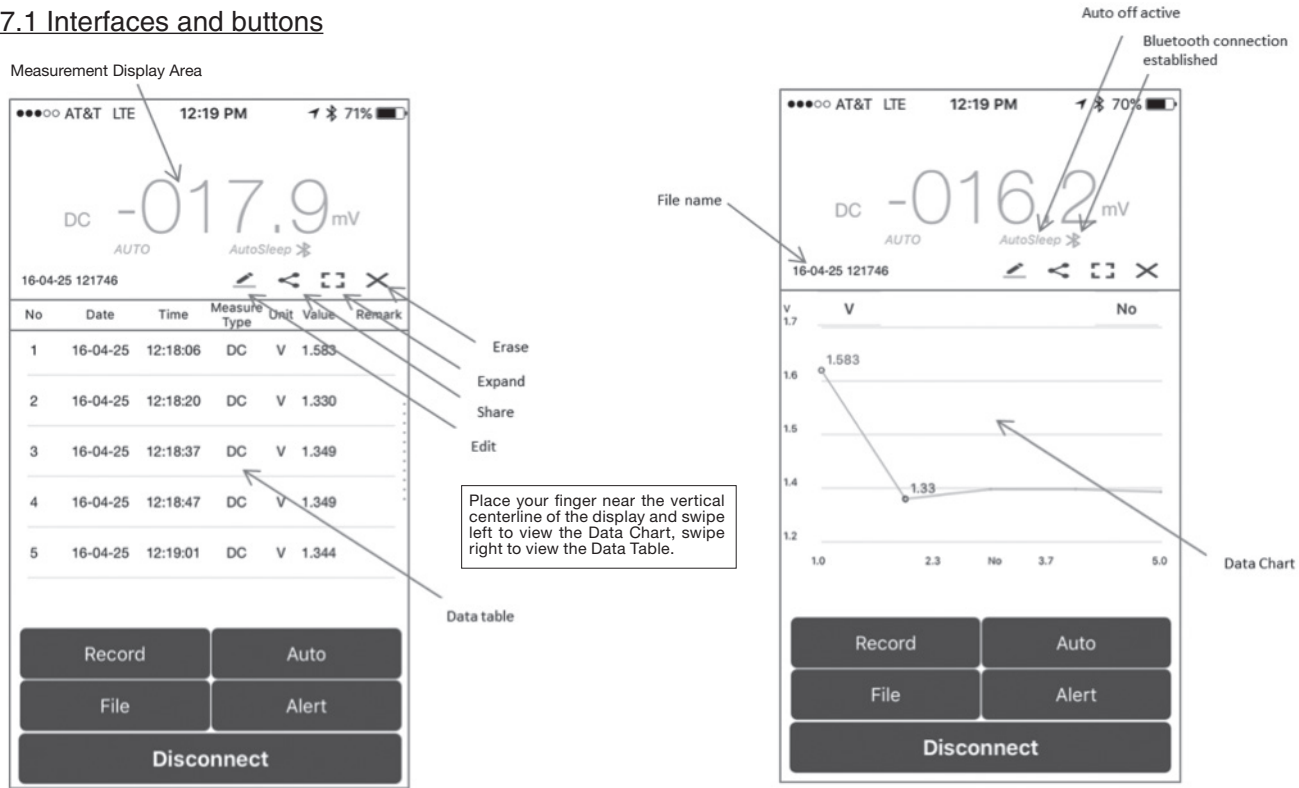

7.2 Download the Application

1. Using either App Store® for Apple® or Google Play™ store for Android™ platforms, search for “Sperry Smart Meter” and select “GET” for Apple® or “Install” for Android™
2. Once the application has finished installing the SperrySmartMeter app icon will appear on your device.



7.3 Opening the Application

1. Locate the Sperry SMARTmeter app.
2. Touch the icon to open.



7.4 Connecting Your Smart Device

1. Make sure that your smart device has Bluetooth enabled.
2. Turn on the SMARTmeter by pressing and releasing the SELECT button.
3. Open the SMARTmeter app on your smart device.
4. Touch the “Connect” button on your smart device.
5. Press the “Scan” button on your smart device.
6. A list of devices will appear. Select the device “SDMM10000”
7. The devices are now connected. The Bluetooth symbol (Ⓜ) should appear on both the SMARTmeter and your smart device.

7.5 Data Logging

1. Data can be logged manually by pressing the “Record” button on your smart device for each measurement.
2. Data can be logged automatically by pressing the “Auto” button and inputting the recording length and interval.
3. The recording length is limited to 15 minutes unless the auto-off feature was disabled at start-up.
4. The time base can be set to hours, minutes or seconds.
5. Once the length and interval have been entered press the “OK” button to begin recording.
6. After the “OK” button is pressed, your smart device will record the first data point immediately and you will be prompted to name the file or accept the default file name.
7. Data points will continue to be recorded for the duration and interval specified.
8. If you wish to terminate the auto recording of data points simply press the “Stop” button on your smart device.
9. After the duration has elapsed your smart device will stop recording data points, but the readings will continue to be displayed. (The data must be saved after testing is complete. See Data file management 7.7)

7.6 Alert

1. An alert can be set up to notify the user when readings are displayed that are outside of a set range.
2. To set up an alert press the “Alert” button and input the maximum value and minimum value.
3. The max / min values can be input in decimal form by selecting “Null” or by using the SI unit of measure prefixes n, μ , m, k, M.
4. After entering the values, select “On” and press “OK”.
5. Your smart device will emit a beeping sound if the value displayed exceeds the range entered.
6. To deactivate the alert press the “Alert” button, select “Off” and press “OK”.

7.7 Data File Management

7.7.1 Rename & Save

1. Once data has been collected it can be given a unique file name by pressing the “File” button.
2. The screen that appears will allow you to rename the file or accept the default file name.
3. Name the file and press save.

7.7.2 Open

1. Previously saved data can be reopened by pressing the “File” button.
2. Press “Open” on the screen that appears.
3. A list of saved files will be displayed.
4. Press on the file that you wish to open.
5. The measurements recorded in this saved file will now be displayed.

7.7.3 Deleting saved files

1. To delete saved files press the “File” button.
2. Press “Open” on the screen that appears.
3. A list of saved files will be displayed.
4. Press “Edit.” (iOS only)
5. Select the file that you wish to remove and press delete.
6. When finished removing files press “Over” to return to the previous screen.

7.7.4 Renaming Saved Files

1. Open the file that you wish to rename.
2. Press “File” and then “Save”.
3. The screen that appears will allow you to rename the file.
4. Name the file and press save.
5. A copy of the file has been saved with the new name.
6. If you no longer require the file with the original name follow the instructions.

7.7.5 Deleting data points

1. Individual data points can be deleted.
2. Press the  symbol. (iOS only)
3. Select the data point that you wish to remove and press delete.

7.7.6 Deleting the data table

1. The entire data table can be deleted.
2. Press the X.
3. Press “Erase.” (iOS only)
4. The data table will be cleared.
5. If the data was previously saved it can be reopened.

7.7.7 Remarks

1. To add a comment about an individual data point press the blank space in the remark column.
2. The screen that appears will allow you to enter a comment.
3. Enter the comment and press “Back” to return to the previous screen.
4. Your comment will now be displayed in the “Remark” column .

7.8. Data File Sharing

7.8.1 Sharing as a Table

1. Open a file or record data.
2. Press the share symbol .
3. You will be prompted to save the file. (iOS only)
4. If you wish to change the name enter the new name and press “Save.” (iOS only)
5. If you wish to continue sharing with the default or previously assigned name just press “Save.” (iOS only)
6. You will be given the option to “Share data”, “Share picture” and “Cancel”.
7. Selecting “Share Data” will open allow you to share the data via a number of applications.
8. The data will be shared in .xml format.

7.8.2 Sharing as an Image

1. Open a file or record data.
2. Press the share symbol .
3. You will be prompted to save the file. (iOS only)
4. If you wish to change the name enter the new name and press “Save.” (iOS only)
5. If you wish to continue sharing with the default or previously assigned name just press “Save.” (iOS only)
6. You will be given the option to “Share data”, “Share picture” and “Cancel.”
7. Selecting “Share picture” will allow you to share the data chart via a number of applications.

CAUTION

- Do not mix old and new batteries.
- Install batteries in correct polarity as indicated in the Battery Compartment.

8. Battery Replacement

Replace the batteries when a low battery symbol  is displayed on the LCD screen. When the battery is completely exhausted, the display will appear blank and no symbol will be shown.

1. Press and hold the SELECT button until the unit powers off.
2. Remove the screw on the back of the unit with a small Philips head screw driver.
3. Remove the back cover.
3. Replace the batteries observing correct polarity.
4. Use new (2) LR44 1.5V batteries.
5. Reinstall the cover and replace the screw to secure the cover.

9. Maintenance

- Cleaning: Use only a soft cloth dampened with water or neutral detergent for cleaning the meter. Do not use abrasives, solvents or harsh chemicals. Allow to dry thoroughly before use.

SPERRY INSTRUMENTS LIMITED LIFETIME WARRANTY

Subject to the exclusions and limitations detailed below, Sperry Instruments provides a limited lifetime warranty on products of its manufacture will be free from defects in materials and workmanship under normal use and service.

Limited

Limited means that Sperry Instruments warrants to the original purchasers of products from Sperry Instruments authorized distributors at the time of shipment such products shall be free of defects in material and workmanship while the tool is used under normal working conditions. Standard wear and tear, dulling over time, overloading, misuse, and acts of God are not covered under warranty. This warranty does not cover batteries, fuses, or test leads.

When a warranty claim arises, the purchaser must contact Sperry Instruments. If the defect comes under the terms of this limited warranty, Sperry Instruments will arrange, at its sole discretion, one of the following options:

- Product will be replaced

The purchaser is solely responsible for determining the suitability of Sperry products for the purchaser's use or resale, or for incorporating them into articles or using them in the purchaser's applications. The distributor is authorized to extend the foregoing limited warranty to its original purchasers in connection with the sales of Sperry products, provided that such products shall not have been altered by the distributor. The distributor shall be fully responsible for any warranties the distributor makes to its purchasers which are broader or more extensive than Sperry's limited warranty.

Lifetime Warranty

Warranty Limitation: The foregoing warranties are exclusive and are in lieu of all other express and implied warranties whatsoever, including but not limited to implied warranties of merchantability and fitness for a particular purpose. The foregoing warranties do not cover ordinary wear and tear, abuse, misuse, overloading, alterations, products which have not been installed, operated or maintained in accordance with Sperry's written instructions. Test leads, fuses, batteries and calibration are not covered under any implied warranty. "Lifetime" of products that are no longer offered by Sperry will be either repaired or replaced with an item of Sperry Instruments choice of similar value. Lifetime is defined as 5 years after Sperry discontinued manufacturing the product, but the warranty period shall be at least ten years from date of purchase. Original proof of purchase is required to establish original ownership of product.

No warranty will be honored unless an invoice or other proof of purchase date is provided to Sperry Instruments. Hand written receipts or invoices will not be honored.

©2016 Product Power, LLC All rights reserved.

- See more at: <http://www.sperryinstruments.com/en/resources/warranty-page#sthash.4sNKZu3b.dpuf>

SPERRY® INSTRUMENTS

Sperry Instruments
800-645-5398
Menomonee Falls, WI 53051
sperryinstruments.com

*** Note:**

- The warranty is not applicable if the instrument has been: misused, abused, subjected to loads in excess of specifications, has had unauthorized repair or has been improperly assembled or used.
- Sperry does not calibrate or repair any meters.
- Conforms to UL STD.61010-1,61010-2-030. Certified to CSA STD. C22.2 No. 61010-1,61010-2-030.